

Brutoprijzen excl. BTW en taksen geldig vanaf 01/08/2024 tot 31/12/2024
 Prix brut hors TVA et taxes valable du 01/08/2024 jusqu'au 31/12/2024

Galaxy Multi Battery Hybrid

AC/DC Hybrid

BATTERY

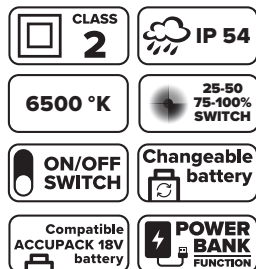

CABLE



LM 0225E
 LM 03305
 (pag. 15)



NEW

8000
 Lumen

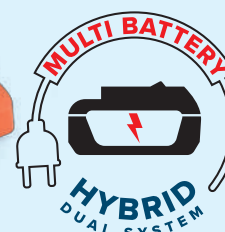

+6 adapters inbegrepen
 adaptateurs inclus

Bosch (LM 30101)
 Makita (LM 30102)
 Metabo (LM 30103)
 Milwaukee/Dewalt (LM 30104)
 Stanley (LM 30105)
 Hikoki (LM 30106)

GALAXY HYBRID

MULTI BATTERY 50W 18V

code	Barcode	i	Dimensions	Weight	Quantity	Price
LM 30085	5420000070288	50 W	380 x 320 x 145 mm	4	96	99,80

Batterij niet inbegrepen / Batterie non incluse

LED M-65 Multi-battery Hybrid

AC/DC Hybrid

BATTERY

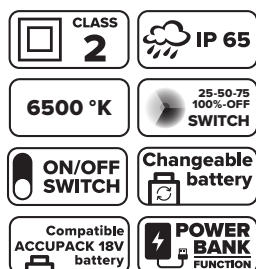

CABLE



LM 0225E
 LM 03305
 (pag. 15)



6500
 Lumen

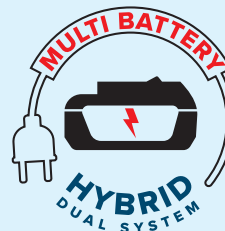

+6 adapters inbegrepen
 adaptateurs inclus

Bosch (LM 30101)
 Makita (LM 30102)
 Metabo (LM 30103)
 Milwaukee/Dewalt (LM 30104)
 Stanley (LM 30105)
 Hikoki (LM 30106)

MULTI BATTERY

HYBRID 65W 18V

code	Barcode	i	Dimensions	Weight	Quantity	Price
LM 30065	5420000066830	65 W	250 x 157 x 313.5 mm	4	48	139,00
LM 02995	5420000067295	LM 0225E/ LM 03305	-	1	-	4,18

Adapter voor bevestiging op statieven • Adaptateur pour montage sur trépieds



Batterij niet inbegrepen / Batterie non incluse

LED M-30 Multi-battery

CLASS **3**
 IP **54**
 6500 °K
 25-50-75 100%-OFF SWITCH
 ON/OFF SWITCH
 Changeable battery
 Compatible ACCUPACK 18V battery
 POWER BANK FUNCTION
 3 year WARRANTY ON THE LED
 CE



NEW 3600 Lumen
MULTI BATTERY
30W 18V



LM 0225E
LM 03305
(pag. 15)



code	Barcode	i	Dimensions	Weight	Accessories	€
LM 29930	5420000071018	30 W	232 x 142 x 270 mm	6	-	59,95

Batterij niet inbegrepen / Batterie non incluse

5 adapters beschikbaar
adaptateurs disponibles
Niet inbegrepen / Non-inclus

- Bosch® (LM 30101)
- Stanley® (LM 30105)
- Metabo® (LM 30103)
- Milwaukee®/Dewalt® (LM 30104)
- Hikoki® (LM 30106)

LED M-45 Multi-battery

CLASS **3**
 IP **65**
 6500 °K
 25-50-75 100%-OFF SWITCH
 ON/OFF SWITCH
 Changeable battery
 Compatible ACCUPACK 18V battery
 POWER BANK FUNCTION
 3 year WARRANTY ON THE LED
 CE



4500 Lumen

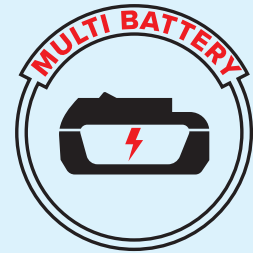

LM 0225E
LM 03305
(pag. 15)



MULTI BATTERY + **6** adaptateurs inclus
45W 18V

Bosch (LM 30101) • Makita (LM 30102)
Metabo (LM 30103) • Milwaukee/Dewalt (LM 30104)
Stanley (LM 30105) • Hikoki (LM 30106)

code	Barcode	i	Dimensions	Weight	Accessories	€
LM 30000	5420000066823	45 W	230 x 156 x 290 mm	6	48	95,00
Adapter voor bevestiging op statieven • Adaptateur pour montage sur trépiéds						
LM 02995	5420000067295	LM 0225E/ LM 03305	-	1	-	4,18

Batterij niet inbegrepen / Batterie non incluse
Zolang de voorraad strekt / Jusqu'à épuisement du stock

Multi-battery GALAXY Serie



GALAXY
MULTI BATTERY
SMD LED TECHNOLOGY
50W

LM 0225E
LM 03305
(pag. 15)

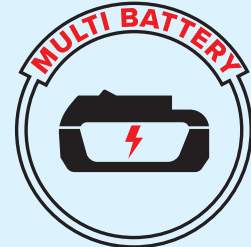

MULTI BATTERY +6 adapters inbegrepen
50W 18V *adaptateurs inclus*

Bosch (LM 30101) • Makita (LM 30102)
Metabo (LM 30103) • Milwaukee/Dewalt (LM 30104)
Stanley (LM 30105) • Hikoki (LM 30106)

code	Barcode	Info	Dimensions	Weight	Quantity	Price	ACTIE ACTION
LM 30080	5420000067578	50 W	320 x 145 x 380 mm	4	44	98,50	79,00

5000 Lumen

Batterij niet inbegrepen / Batterie non incluse
Zolang de voorraad strekt / Jusqu'à épuisement du stock

Multi-battery LED MT-100



1200 Lumen



LED MT-100
SMD LED TECHNOLOGY
2x50W
MULTI BATTERY

+6 adapters inbegrepen
adaptateurs inclus



Bosch (LM 30201) • Makita (LM 30202) •
Metabo (LM 30203) •
Milwaukee/Dewalt (LM 30204) •
Stanley/Black & Decker (LM 30205) •
Festool (LM 30206)

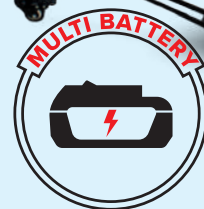
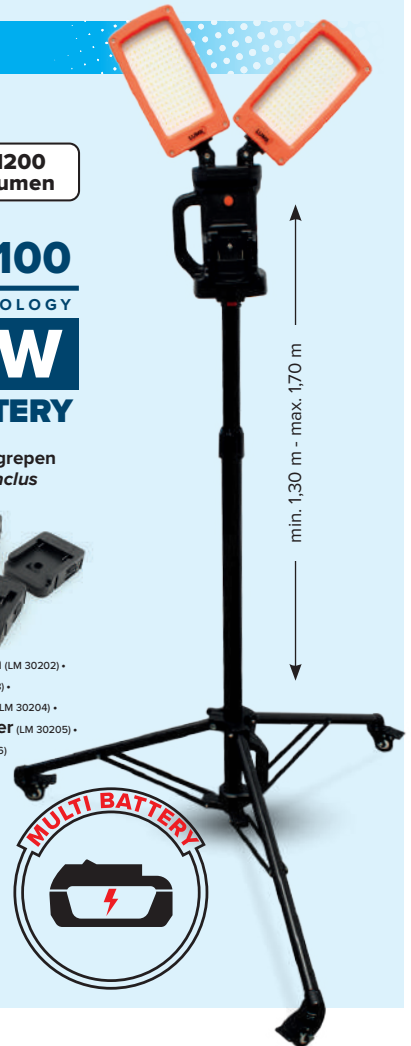

code	Barcode	Info	Dimensions	Weight	Quantity	Price	ACTIE ACTION
LM 30200	5420000066892	2 x 50 W	850 x 850 x 1300 mm	3	36	220,00	175,00

Batterij niet inbegrepen / Batterie non incluse
Zolang de voorraad strekt / Jusqu'à épuisement du stock

LED XS-Serie

CLASS 3	IP 54	6500 °K	25-50-100% FLASH-OFF SWITCH	CE
3,7 V 2200 mAh LITHIUM	±2-3 hrs	±6-8 hrs	incl.	USB-C rechargeable

Display per 6 stuks
Display par 6 pièces



1000 Lumen

LED XS-10
COB LED TECHNOLOGY
10W
RECHARGEABLE



met karabinhaak
avec mousqueton



magnetische voet
pied magnétique

code						€
LM 16410	5420000066236	10 W	100 x 100 x 40 mm	6	648	29,00

LED CL-Serie

CLASS 3	IP 65	6500 °K	25-50-100% OFF SWITCH	CE	
3,7 V 5000 mAh LITHIUM	±4 hrs	±12 hrs	POWER BANK FUNCTION	incl.	USB-C rechargeable



1800 Lumen

NEW
LED CL-20
SMD LED TECHNOLOGY
20W
RECHARGEABLE



code						€
LM 16620	5420000070998	20 W	205 x 85 x 175 mm	10	-	48,00

LED C-Serie

CLASS 3	IP X6	6500 °K	25-50-100% RED-FLASH OFF SWITCH	MAGNETIC feet	CE
3,7 V 4000 mAh LITHIUM	±5 hrs	±9 hrs	POWER BANK FUNCTION	incl.	USB-C rechargeable



LM 0225E
LM 03305
(pag. 15)



2000 Lumen

NEW

LED C-2000

COB LED TECHNOLOGY

20W

RECHARGEABLE



met ophanghaak
avec crochet de suspension



magnetische voet
pied magnétique



Ophangen dankzij
schroeven
Suspendre avec
des vis

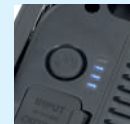

Batterij
Led indicator
Indicateur de
batterie LED

code						€
LM 16700	5420000070974	20 W	180 x 59 x 155 mm	10	-	49,30

GALAXY RECHARGEABLE Serie

CLASS 3	IP 54	6500 °K	50-100% SWITCH	11,1 V 4400 mAh LITHIUM	±7-8 hrs	2,5 4,5 hrs	incl.	CE
---------	-------	---------	----------------	-------------------------	----------	-------------	-------	----



LM 0225E
LM 03305
(pag. 15)



2400 Lumen

GALAXY

SMD LED TECHNOLOGY

30W

RECHARGEABLE



LED-indicator / indicateur LED



Twisted support

code						€	ACTIE ACTION
LM 32230	5420000049161	30 W	385 x 315 x 70 mm	5	120	112,00	102,00

LED R-Serie

CLASS 3
 IP 54
 4000 °K
 25-50-100% OFF SWITCH
 MAGNETIC feet
 incl.
 POWER BANK FUNCTION
 USB-C rechargeable
 CE

±4-5 hrs
 ±3 hrs
 3,7V 4400 mAh LITHIUM
1000 Lumen



LED R-10
 SMD LED TECHNOLOGY
10W
 RECHARGEABLE

±4-5 hrs
 ±3 hrs
 3,7V 6600 mAh LITHIUM
2000 Lumen



LED R-20
 SMD LED TECHNOLOGY
20W
 RECHARGEABLE

code	Barcode	Info	Dimensions	Weight	Quantity	Price
LM 32110	5420000065444	10 W	239 x 167 x 118 mm	12	288	53,50
LM 32120	5420000065451	20 W	286,5 x 221,5 x 133 mm	8	144	78,70

LED-verlichting | Éclairage LED

DUAL LED RS-50

DUAL SYSTEM

BATTERY
 CLASS 3
 IP 54
 5000 °K
 50-100% SWITCH
 ON/OFF SWITCH
 7,4 V 8800 mAh LI-ION
 ±3 hrs
 ±3 hrs
 incl.
 Changeable battery
 POWER BANK FUNCTION
 CE

CABLE
 CLASS 2
 IP 44
 5m H05RN-F (2X 1,0 mm²) NEOPRENE
 100-240V 50/60H



5000 Lumen

LED RS-50

COB LED TECHNOLOGY
50W
 RECHARGEABLE/220V



DUAL SYSTEM

LM 0225E
 (pag. 15)

MAGNETIC feet

code	Barcode	Info	Dimensions	Weight	Quantity	Price	Special
LM 30350	5420000049567	50 W	300 x 265 x 130 mm	4	96	158,00	ACTIE ACTION 149,00
Reserver accu voor LM 30350 • Batterie de rechange pour LM 30350							
LM 30355	5420000049574	7,4V 8800 mAh	-	1	-	70,00	



GALAXY-Serie

CLASS 1
 IP 54
 6500 °K
 3m HO7RN-F (3G 1,5 mm²) NEOPRENE
 CE

3 year WARRANTY ON THE LED



LM 0225E
LM 03305
(pag. 15)



16A + T

ON/OFF SWITCH

USB connection

2500 Lumen

GALAXY COMPACT
 SMD LED TECHNOLOGY
24W



16A + T

50-100% SWITCH

4950 Lumen

GALAXY
 SMD LED TECHNOLOGY
45W



16A + T

50-100% SWITCH

9200 Lumen

GALAXY
 SMD LED TECHNOLOGY
80W



kabelprolsysteem
système d'enroulage de cable



verdraaide steun
support torsadé



KABELPROLSYSTEEM - SYSTÈME D'ENROULAGE DE CÂBLE

code	Barcode	i	Dimensions	Weight	Quantity	€
LM 32232	5420000059320	24 W	290 x 234 x 83 mm	6	120	64,00
LM 32245	5420000046498	45 W	385 x 315 x 90 mm	4	96	86,30
LM 32300	5420000065017	80 W	464 x 365 x 84 mm	4	64	131,00

LED P+ Serie

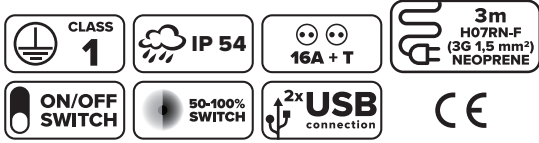

LM 0225E
(pag. 15)

LED P+100

SMD LED TECHNOLOGY

8800
Lumen

100W



COLOR
TEMPERATURE
SELECTION

ALL-IN-ONE

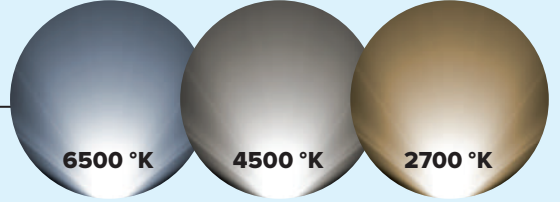

LED P+60

SMD LED TECHNOLOGY

5300
Lumen

60W



16A + T



kabelprolsysteem
système d'enroulage de cable



rubberen schokbescherming
protection antichoc en caoutchouc



code	Barcode	Power	Dimensions	Quantity	Weight	Price
LM 33595	5420000065000	60 W	300 x 305.5 x 82 mm	4	96	120,00
LM 33600	5420000063273	100 W	368 x 346 x 92 mm	4	80	150,00

LED P-100



NEW

LM 0225E
(pag. 15)

11500
Lumen

LED P-100
SMD LED TECHNOLOGY
100W

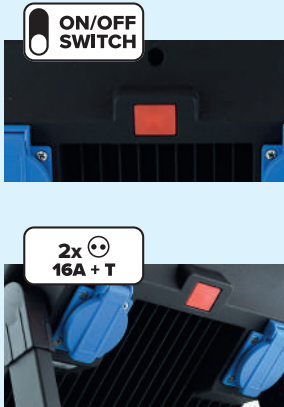

code	Barcode	i	Dimensions	Weight	Quantity	Price
LM 33590	5420000067660	100 W	342 x 295 x 116 mm	4	48	129,00

LED LB-50

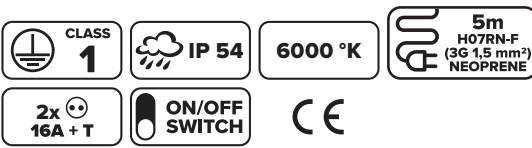

LM 0225E
(pag. 15)

5500
Lumen

LED LB-50
SMD LED TECHNOLOGY
50W



code	Barcode	i	Dimensions	Weight	Quantity	Price
LM 37500	5420000062153	50 W	280 x 286 x 280 mm	4	40	99,80

LED F-Serie



LED F-20

SMD LED TECHNOLOGY

1800 Lumen

20W



LED F-30

SMD LED TECHNOLOGY

2500 Lumen

30W



LED F-50

SMD LED TECHNOLOGY

4200 Lumen

50W

code	Barcode	ⓘ	Dimensions	Box	Weight	€
LM 36120	5420000049536	20 W	264 x 238,5 x 148,6 mm	8	160	31,50
LM 36130	5420000049543	30 W	288,6 x 288 x 168,5 mm	6	120	47,30
LM 36150	5420000049550	50 W	318,5 x 308 x 183 mm	4	96	61,00

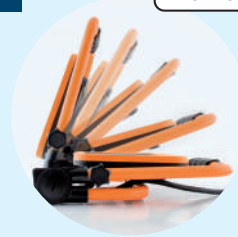

LED FT-Serie



LED FT-50

SMD LED TECHNOLOGY

50W

4200 Lumen

LED FT-60

SMD LED TECHNOLOGY

2 x 30W

5000 Lumen

min. 0,95 m - max. 1,63 m

min. 0,92 m - max. 1,66 m

code	Barcode	ⓘ	Dimensions	Box	Weight	€
LM 36500	5420000063280	50 W	260 x 285 x 40 mm	2	18	76,10
LM 36660	5420000060135	60 W	570 x 250 x 40 mm	2	24	99,20

LED N-Serie



LED N-50

SMD LED TECHNOLOGY

4580 Lumen

50W



LED N-80

SMD LED TECHNOLOGY

7200 Lumen

80W

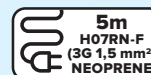

LED N-120

SMD LED TECHNOLOGY

10800 Lumen

120W



code	Barcode	Info	Dimensions	Weight	Quantity	Price
LM 34750	5420000060050	50 W	330 x 315 x 220 mm	4	32	95,00
LM 34780	5420000060067	80 W	400 x 354 x 258 mm	3	36	139,00
LM 34812	5420000060074	120 W	500 x 440 x 295 mm	2	12	275,00

LED B-180



LED B-180

SMD LED TECHNOLOGY

16000 Lumen

180W



code	Barcode	Info	Dimensions	Weight	Quantity	Price
LM 35180	5420000060128	180 W	530 x 400 x 360 mm	2	16	295,00

LL-24

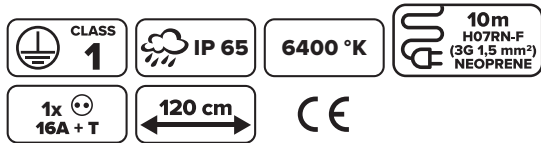

Max. 10



CLIPS INCLUDED



LED Doorlusverlichting
Éclairage en boucle LED



2650
Lumen

LL-24
SMD LED TECHNOLOGY
24W

code	Barcode	Info	Dimensions	Quantity	Weight	Price
LM 36724	5420000062177	24 W	1200 x 72 x 58 mm	6	90	73,70

LED LS-Serie



200
Lumen/m

LED lichtslang - 15 m
Bande LED - 15 m

LED lichtslang - 50 m
Bande LED - 50 m



LS-15
SMD LED TECHNOLOGY
45W



45 + 5m GRATIS GRATUIT

LS-45
SMD LED TECHNOLOGY
128W

code	Barcode	Dimensions	Quantity	Weight	Price	ACTIE ACTION
LM 23015	5420000070134	264 x 251 x 88 mm	4	72	49,00	42,00
LM 23046	5420000065383	264 x 251 x 128 mm	1	96	160,00	129,00

inclusief stekker / prise incluse

Toebehoren / Accessoires

voor LED lichtslang LS-Serie
pour bande LED LS-Serie

code	Barcode	Quantity	Price	ACTIE ACTION
LM 23050	5420000062405	1	16,83	14,00



INHOUD - CONTENU :

- 1x T-connector
- 3x Pin-connector
- 3x Eindstuk/embout
- 1x PVC lijm/colle
- 1x EU stekker/fiche + kabel/câble 1,5m H05RN-F 2X 1,0 mm²

WS-Serie LED Wandstraler • Projecteur murale LED



NEW

3 year WARRANTY ON THE LED

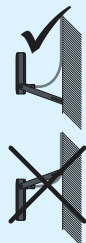

WS-20

SMD LED TECHNOLOGY

1900 Lumen

20W



WS-30

SMD LED TECHNOLOGY

2850 Lumen

30W



WS-50

SMD LED TECHNOLOGY

4700 Lumen

50W

code	Barcode	i	Dimensions	Weight	Quantity	€
LM 31420	5420000067035	20 W	159 x 51,5 x 142 mm	16	350	22,40
LM 31430	5420000067042	30 W	199 x 54,5 x 175 mm	10	384	33,80
LM 31450	5420000067059	50 W	229 x 56 x 198 mm	8	192	46,50

WSS-Serie LED Wandstraler • Projecteur murale LED



NEW

SENSOR

3 year WARRANTY ON THE LED

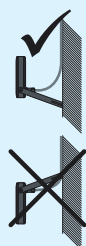

WSS-20

SMD LED TECHNOLOGY

1900 Lumen

20W



WSS-30

SMD LED TECHNOLOGY

2850 Lumen

30W



WSS-50

SMD LED TECHNOLOGY

4700 Lumen

50W

code	Barcode	i	Dimensions	Weight	Quantity	€
LM 31920S	5420000067066	20 W	159 x 53,5 x 189 mm	16	320	29,20
LM 31930S	5420000067073	30 W	199 x 56,5 x 221 mm	10	240	45,10
LM 31950S	5420000067080	50 W	229 x 57,5 x 245,5 mm	8	144	58,50



LED HP-Serie

CLASS 1
 IP 65
 6500 °K
 15m H07RN-F (3G 1,5 mm²) NEOPRENE
 CE

3 year WARRANTY ON THE LED



LM 0225E
LM 03305
(pag. 15)

GENERATION

LIGHTER • BRIGHTER • ECONOMICAL



LED HP-150
SMD LED TECHNOLOGY
150W

13400 Lumen



LED HP-200
SMD LED TECHNOLOGY
200W

18250 Lumen



LED HP-400
SMD LED TECHNOLOGY
400W

37600 Lumen



HIGH POWER LEDS

statief niet inbegrepen
trépied non inclus



60000 Lumen

0,3m H07RN-F (3G 1,5 mm²) NEOPRENE

IP 66

LED HP-600
COB LED TECHNOLOGY
600W
HIGH LUMEN

code	Barcode	Info	Dimensions	Mounting	Beam	Price	ACTIE ACTION
LM 61015	5420000060098	150 W	345 x 280 x 68 mm	2	48	228,00	195,00
LM 61020	5420000060104	200 W	425 x 325 x 77 mm	2	32	283,00	
LM 61040	5420000060111	400 W	595 x 475 x 95 mm	2	18	525,00	450,00
LM 61260	5420000064836	600 W	560 x 470 x 110 mm	1	18	563,00	

STATIEVEN • TRÉPIEDS



LM 0225E

Min: 1,09 m
Max: 2,75 m

max
30 kg



Heavy Duty

LM 03305

Min: 1,40 m
Max: 3,00 m

max
60 kg



extra beveiliging
broche anti-chute

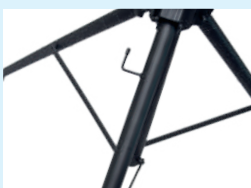

kabelprolsysteem
système d'enroulage de câble



werflamp niet inbegrepen
lampe de chantier non inclus

code	barcode	height	width	depth	€	ACTIE ACTION
LM 0225E	5420000018938	1,09 → 2,75 m	3	36	53,90	45,00
LM 03305	5420000062412	1,40 → 3,00 m	2	36	123,00	110,00

	LM 29930 LM 30000 LM 30065 LED M-Series	LM 33590 LM 33595 LM 33600 LED P/P+ Serie	LM 32300 LM 32245 LM 32232 GALAXY-Serie	LM 32230 GALAXY Rechargeable	LM 30085 GALAXY Hybrid	LM 30350 LED RS-50	LM 37500 LED LB-50	LM 16700 LED C-2000	LM 61015 LM 61020 LM 61040 LM 61260 LED HP-Serie
LM 0225E	✓	✓	✓	✓	✓	✓	✓	✓	✓
LM 03305	-	-	✓	✓	✓	-	-	✓	✓

HL-250

- IP 64
- 6100 °K / 7100 °K
- Incl. 3,7 V 800 mAh LFPOLYMER
- ou 3 x AAA (not incl.)
- Changeable battery
- ±2,5 hrs
- USB rechargeable
- SHOCK RESISTANT
- 2m
- incl.
- CE

HL-250

SMD LED TECHNOLOGY

5 modes

250 Lumen



code	barcode	i	box	€	ACTIE ACTION
LM 12325	5420000061750	HL-250	6	47,70	45,00

HL-350

- IP X4
- 6500 °K
- Incl. 3,7 V 1200 mAh LITHIUM
- ±2,5 hrs
- USB rechargeable
- SHOCK RESISTANT
- 2m
- incl.
- CE

HL-350

COB/XPE LED TECHNOLOGY

5 modes

350 Lumen

(((SENSOR)))

Flexible rubber band



code	barcode	i	box	€
LM 12005	5420000065666	HL-350	12	18,00

TCT-250S

- LUMILEDS The Brighter Choice
- IP X4
- 6500 °K
- 3 x AAA DURACELL (incl.)
- SHOCK RESISTANT
- 2m
- CE

TCT-250S

SMD LED TECHNOLOGY

8 modes

250 Lumen

(((SENSOR)))



code	barcode	i	box	€
LM 12440	5420000061767	TCT-250S	6	38,00

TCT-300

- IP 64
- 7100 °K / 8300 °K
- Incl. 3,7 V 2600 mAh Li-ion
- ±4 hrs
- Changeable battery
- USB rechargeable
- SHOCK RESISTANT
- 2m
- incl.
- CE

TCT-300

SMD LED TECHNOLOGY

6 modes

300 Lumen



code	barcode	i	box	€
LM 12590	5420000061774	TCT-300	6	61,40

TCT-375B

- IP 64
- 7500 °K
- LUMINUS
- 3 x AA DURACELL (incl.)
- SHOCK RESISTANT 2m
- CE

TCT-375B

SMD LED TECHNOLOGY

6 modes
375 Lumen



code	Barcode	Info	Quantity	Price	ACTIE ACTION
LM 12195	5420000067165	TCT-375B	6	31,10	27,70

TCT-640

- IP 66
- 6500 °K / 7100 °K
- Incl. 3,8 V 1900 mAh LI-ION or 3 x AA (not incl.)
- Changeable battery
- ±2,5-3 hrs
- USB rechargeable
- SHOCK RESISTANT 2m
- incl. CE

TCT-640

COB LED TECHNOLOGY

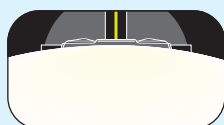

Ultrabrede verlichting
Éclairage ultra-large

6 modes
640 Lumen



code	Barcode	Info	Quantity	Price	ACTIE ACTION
LM 12600	5420000063068	TCT-640	6	69,00	62,50

TCT-755

- IP 66
- 7000 °K
- Incl. 3,7 V 6400 mAh LI-ION or 4 x AA (not incl.)
- Changeable battery
- ±8,5 hrs / ±10,5 hrs
- USB rechargeable
- SHOCK RESISTANT 2m
- incl. CE

TCT-755

SMD LED TECHNOLOGY



5 modes
755 Lumen



With LED Focus Control

code	Barcode	Info	Quantity	Price
LM 12755	5420000068773	TCT-755	6	89,00

DUO LED

CLASS 3
 IP 20
 4000 °K
 3 x AAA (incl.)
 ±10 hrs
20+3 LED

80 Lumen

DUO LED
BULB & SMD LED TECHNOLOGY
BATTERY



MAGNETIC foot

Display per 12 st.
Display par 12 pcs.



code	Barcode	Info	Dimensions	Quantity	Price
LM 52000	5420000039285	20 + 3 LED	100 x 70 x 30 mm	12	8,73

PEN LIGHT-L

CLASS 3
 IP X2
 6500 °K
 incl. USB-C
 3,7 V 800 mAh Lithium
 2 hrs
 2 hrs
 DIMMABLE

400 Lumen

PEN LIGHT-L
UV + LASER
COB LED TECHNOLOGY
5W
RECHARGEABLE

100 Lumen
2 hrs



120°



Laser



UV 365 nm



USB-C rechargeable



Display per 16 st.
Display par 16 pcs.

PEN LIGHT

CLASS 3
 IP X2
 6500 °K
 3,7 V 500 mAh Lithium
 USB-C rechargeable
 2,5 hrs
 3 hr High
 DIMMABLE

100 Lumen
3 hrs



360°

PEN LIGHT
SMD + COB
LED TECHNOLOGY
3W
RECHARGEABLE

NEW

250 Lumen



Display per 16 st.
Display par 16 pcs.

code	Barcode	Info	Dimensions	Quantity	Price
LM 51850	5420000070776	SMD+COB	15,8 x 20 x 135 mm	16	14,50



2024

Brutoprijzen excl. BTW en taksen geldig vanaf 01/08/2024 tot 31/12/2024 - Prix brut hors TVA et taxes valable du 01/08/2024 jusqu'au 31/12/2024

SLIM LIGHT SERIE

NEW

CLASS 3
 IP 20
 6500 °K
 USB-C rechargeable
 SHOCK RESISTANT 2m
 50-100% SWITCH
 incl.
 CE



ophangbaar
mise en suspension



120 Lumen

5 MODES

400 Lumen

3,7 V
800 mAh
LI-ION

±2,5 hrs

±3 hrs

MAGNETIC foot



5 MODES

600 Lumen

3,7 V
1600 mAh
LI-ION

±3 hrs

±6 hrs

MAGNETIC foot



Display per 10 st.
Display par 10 pcs



code	Barcode	W	Dimensions	Qty	€
LM 51030	5420000068735	3 W	160 x 33 x 20 mm	10	21,70
LM 51250	5420000068742	5 W	210 x 33 x 20 mm	10	26,90



INSPEC PRO SERIE

CLASS 3
 CE

NEW

500 Lumen
 IP 65
 5000 °K
 USB-C rechargeable
 incl.

150 Lumen
10 hrs



ophangbaar
mise en suspension

80 Lumen
30 hrs



bevestigbaar met clip
clip de fixation

(TILTABLE)



INSPEC PRO MINI
SMD LED TECHNOLOGY

5W

RECHARGEABLE



800 Lumen
 IP 54
 7000 °K
 USB-C rechargeable
 incl.

INSPEC PRO
SMD LED TECHNOLOGY

5W

RECHARGEABLE



code	Barcode	W	Dimensions	Qty	€
LM 52120	5420000070981	5 W	180 x 33 x 35 mm	10	24,30
LM 52125	5420000042490	5 W	211 x 111 x 56 mm	20	44,20

INSPEC DUO MINI

CLASS 3
 IP X6
 6500 °K
 30-100% TOP SWITCH
 ON/OFF SWITCH
 CE

3.7 V 4000 mAh LI-ION
 ±3 hrs
 ±12 hrs
 USB-C rechargeable
 incl.



ophangbaar
mise en suspension



LED-indicator
indicateur LED

INSPEC DUO MINI
COB+SMD LED TECHNOLOGY
6W
RECHARGEABLE

code	barcode	i	dimensions	quantity	price
LM 52115	5420000071056	6 W	185 x 50 x 32 mm	30	34,00



NEW

600 Lumen



200 Lumen



MAGNETIC foot

INSPEC DUO GRIP

CLASS 3
 IP 20
 7000 °K
 3.7 V 2600 mAh LITHIUM
 CE

4 hrs
 4 hrs
 POWER BANK FUNCTION
 USB-C rechargeable
 incl.



30 Lumen



MAGNETIC foot

INSPEC DUO GRIP
COB LED TECHNOLOGY
3W
RECHARGEABLE

code	barcode	i	dimensions	quantity	price	ACTIE ACTION
LM 52114	5420000068469	3 W	245 x 58,5 x 45,8 mm	24	26,60	22,00



TILTABLE

300 Lumen



LED T-1000

CLASS 3
 IP 66
 7100 °K
 USB rechargeable
 CE

3.7 V 2600 mAh LI-ION
 4 hrs
 4 hrs
 POWER BANK FUNCTION
 incl.

LED T-1000
CREE LED TECHNOLOGY
10W
RECHARGEABLE

1000 Lumen



code	barcode	i	dimensions	quantity	price	ACTIE ACTION
LM 15095	5420000063983	10 W	∅ 29 x 150 mm	6	69,90	65,00

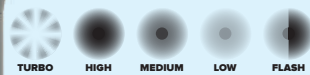

Display per 6 st.
Display par 6 pcs.



1 Micro USB-poort (opladen), 1 USB-poort (Power Bank-functie)
1 port micro USB (charge), 1 port USB (fonction Power Bank)

LED zaklamp waterproof Torche LED étanche

CLASS 3	IP 64	6500 °K
4 x D or 6V 4R25	±25 hrs	CE



420 Lumen



kantelbaar
inclinable



geleverd met draaglint
livré avec bandoulière

code	Barcode	Dimensions	Qty	Price
LM 16360	5420000069879	188 x 148 x 128 mm	6	39,50



LED T-GUN 950 spot light

CLASS 3	IP 67	6100 °K	incl. CE
3,7 V 3000 mAh Li-Ion	4 hrs	1,5 hrs	POWER BANK FUNCTION



950 Lumen

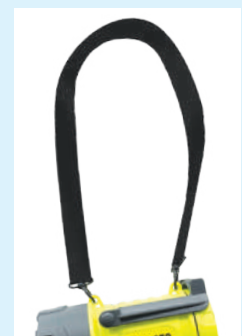

geleverd met draaglint
livré avec bandoulière



handenvrij
mains libres



USB rechargeable

code	Barcode	Dimensions	Qty	Price
LM 18625	5420000064003	148 x 165 x 76 mm	3	91,10

ACTIE ACTION
79,00

tot einde voorraad
jusqu'à épuisement des stocks

LED L-1000

CLASS 3	IP X4	6500 °K	30-100% RED-FLASH OFF SWITCH
3,65 V 8000 mAh LITHIUM	±6 hrs	±25 hrs	CE
POWER BANK FUNCTION	USB-C rechargeable	incl.	

NEW



LED-indicator
indicateur LED



1000 Lumen

600 Lumen



geleverd met draaglint
livré avec bandoulière

LED L-1000
COB+SMD LED TECHNOLOGY
10W
RECHARGEABLE

code	barcode	dimensions	quantity	price
LM 18570	5420000070967	213 x 106 x 132 mm	10	58,75

Zaklampen | Lampes de poche

22

TURBO PRO

CLASS 3	IP 67	6500 °K	CE
7,4 V 2600 mAh LI-ION	±6 hrs	incl.	

1 METER
SUBMERSIBILE



met LOCK-systeem
avec LOCK-système

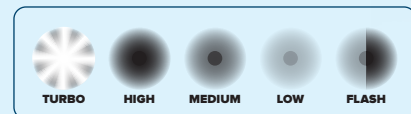

3500 Lumen

code	barcode	dimensions	quantity	price
LM 17005	5420000060579	∅ 62 x 247 mm	2	172,00

TURBO PRO
SMD LED TECHNOLOGY
28W
RECHARGEABLE



Verlengkabels • Rallonges

code					€	ACTIE ACTION
VINYL - H05VV-F						
LM 40515	5420000039681	15 m	8	200	26,80	
LM 40526	5420000034945	25 m	4	144	43,30	
NEOPREEN • NEOPRÈNE - H07RN-F / PLASTIC CAP						
LM 40745	5420000041554	5 m	10	180	19,10	
LM 40750	5420000019607	10 m	4	144	33,80	31,50
LM 40755	5420000041561	15 m	5	90	51,40	
LM 40765	5420000019614	25 m	2	104	76,00	69,80
LM 40770	5420000047488	40 m	2	60	138,00	
NEOPREEN • NEOPRÈNE - H07RN-F / RUBBER CAP						
LM 40605	5420000067776	5 m	50	100	38,50	
LM 40625	5420000066731	25 m	1	35	138,00	



LM 40515
LM 40526



LM 40625

2P+A
2P+T
250V - 16A



LM 40745
LM 40750
LM 40755
LM 40765
LM 40770

Machine-aansluitkabel • Câble de raccordement

230V - 16A



code				€
H07RN-F 3G1,5				
LM 40435	5420000041509	5 m	20	13,13
H05RN-F 2X1,0				
LM 40425	5420000047334	5 m	20	6,72
H07RN-F 2X1,0				
LM 40453	5420000041530	3 m	30	5,56
LM 40455	5420000041547	5 m	20	8,05
H07RN-F 2X1,5				
LM 40443	5420000041516	3 m	30	6,22
LM 40445	5420000041523	5 m	20	10,29

LM 40435

3 geleiders
3 conducteurs



2 geleiders
2 conducteurs

LM 40453

LM 40425



LM 40455



LM 40443
LM 40445



Driewegskoppelstekker • Fiche femelle triple



LM 48310
LM 48325

new design

16A 250V~

Max. 3680W



code				€
LM 48310	5420000046955	10 m	1	87,10
LM 48325	5420000046962	25 m	1	134,40
NI 243300	5420000039612	block	50	10,20
NI 243303	5420000039629	0,3 m	30	14,50
NI 243305	5420000039636	5 m	20	27,00
NI 243310	5420000039643	10 m	8	41,70
NI 243325	5420000039650	25 m	4	79,00

Neopreen verlengkabels • Allonges néoprène



2P+A
2P+T
250V - 16A



code	Barcode	i	Box	€
LM 44102	5420000043015	2 m	25	14,50
LM 44105	5420000066656	5 m	10	23,20



3P+N+A
3P+N+T
400V - 32A

code	Barcode	i	Box	€
LM 44345	5420000043046	25 m	1	236,00



3P+N+A
3P+N+T
400V - 16A

code	Barcode	i	Box	€
LM 44110	5420000043022	10 m	4	69,40
LM 44125	5420000043039	25 m	2	129,20



3P+N+A
3P+N+T
400V - 32A

code	Barcode	i	Box	€
LM 44566	5420000043053	25 m	1	315,60



3P+N+A
3P+N+T
400V - 64A

code	Barcode	i	Box	€
LM 44580	5420000044326	25 m	1	688,00

Verdeelblok - 4 stopcontacten • Bloc multiprises - 4 prises



EN 60309



code	Barcode	i	Box	€	ACTIE ACTION
LM 41200	5420000046542	block	10	25,36	
LM 41203	5420000046559	3 m	10	41,75	32,00
LM 41210	5420000046566	10 m	4	57,90	51,90

Stekkerdozen met schakelaar • Prises avec interrupteur



code				€
2-VOUDIG • DOUBLE				
LM 40800	5420000066762	block	60	2,51
3-VOUDIG • TRIPLE				
LM 40803	5420000043954	1,5 m	40	7,39
4-VOUDIG • QUADRUPLE				
LM 40814	5420000043961	3 m	30	10,43
6-VOUDIG • SEXTUPLE				
LM 40826	5420000058903	5 m	20	15,28
3-VOUDIG + 2 USB-connecties • TRIPLE + 2 connections USB				
LM 40913	5420000064898	1,5 m	40	13,21

LM 40803

LM 40814

LM 40826

LM 40800

LM 40913



Stekker & stopcontact • Prise mâle et femelle



2P+A
2P+T
230V - 50 Hz

LM 48521

LM 48411

LM 48585

LM 48455

code				€
LM 48521	5420000046900	rubber / caoutchouc	30	4,14
LM 48411	5420000046917	rubber / caoutchouc	20	7,38
DUAL SYSTEM				
LM 48585	5420000046931	rubber / caoutchouc	20	5,64
LM 48455	5420000046924	rubber / caoutchouc	10	8,10

DUAL SYSTEM

TOP SERIES!
2X SNELLER MONTEREN
FOIS PLUS VITE MONTÉ

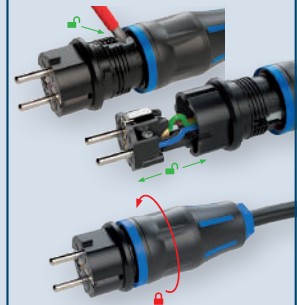

Contactblok met klapdeksel • Prise à clapets



2P+A
2P+T
230V - 50 Hz

LM 48200

LM 48300

code				€
LM 48200	5420000046979	dubbel / double	10	22,92
LM 48300	5420000046948	3-voudig / triple	5	36,50

zonder kabel / sans cable

CEE stekkers (M) - koppelstekkers (V) Fiches CEE male - femelle

EN 60309 CE



2P+A
2P+T
250V - 16A

code	Barcode	Info	Quantity	Price (€)
LM 44730	5420000043060	Man / Male	10	3,82
LM 44835	5420000043114	Vrouw / Femelle	10	5,00



3P+N+A
3P+N+T
400V - 32A

code	Barcode	Info	Quantity	Price (€)
LM 44753	5420000043084	Man / Male	10	7,02
LM 44863	5420000043138	Vrouw / Femelle	10	7,75



3P+N+A
3P+N+T
400V - 16A

code	Barcode	Info	Quantity	Price (€)
LM 44751	5420000043077	Man / Male	10	4,65
LM 44861	5420000043121	Vrouw / Femelle	10	5,68



3P+N+A
3P+N+T
400V - 63A

code	Barcode	Info	Quantity	Price (€)
LM 44755	5420000043091	Man / Male	5	33,40
LM 44865	5420000043145	Vrouw / Femelle	5	42,70



**MORE GRIP
MORE POWER**



3P+N+A
3P+N+T
400V - 16A

code	Barcode	Info	Quantity	Price (€)
LM 44646	5420000066700	Man / Male	10	9,35
LM 44616	5420000066687	Vrouw / Femelle	10	12,60



3P+N+A
3P+N+T
400V - 32A

code	Barcode	Info	Quantity	Price (€)
LM 44662	5420000066717	Man / Male	10	12,55
LM 44632	5420000066694	Vrouw / Femelle	10	14,82

2024

Brutoprijzen excl. BTW en taksen geldig vanaf 01/08/2024 tot 31/12/2024 - Prix brut hors TVA et taxes valable du 01/08/2024 jusqu'au 31/12/2024

CEE Compacte verdeelkasten Coffrets de distributions compactes CEE



LM 46105

LM 46101

LM 46101 - LM 46105

Invoer / Entrée	1 x CEE 16A - 5P - 400V
Uitvoer / Sortie	1 x CEE 16A - 5P - 400V 2 x 16A - 250V
Stekkers / Prises	 F B

code				€
LM 46101	5420000049376	240 x 100 x 80 mm	2	42,90
LM 46105	5420000047099	240 x 100 x 80 mm	2	121,00

LM 46120 - LM 46122

Invoer / Entrée	1 x CEE 16A - 5P - 400V
Uitvoer / Sortie	3 x CEE 16A - 5P - 400V
Stekkers / Prises	Universeel / Universel



LM 46120



LM 46122

code				€
LM 46120	5420000047105	200 x 170 x 80 mm	2	48,80
LM 46122	5420000047112	240 x 170 x 80 mm	2	100,00

LM 46134 - LM 46138

Invoer / Entrée	1 x CEE 16A - 3P - 230V
Uitvoer / Sortie	3 x CEE 16A - 3P - 230V
Stekkers / Prises	Universeel / Universel



LM 46138

LM 46134

code				€
LM 46134	5420000047129	240 x 170 x 80 mm	2	44,30
LM 46138	5420000047136	240 x 170 x 80 mm	2	119,00

LM 46478

LM 46413

Invoer / Entrée	1 x CEE 16A - 5P - 400V	1 x CEE 32A - 5P - 400V
Uitvoer / Sortie	3 x 16A - 250V	3 x CEE 32A - 5P - 400V
Stekkers / Prises	 F B	Universeel / Universel

code				€
LM 46478	5420000047150	200 x 100 x 80 mm	5	37,10
LM 46413	5420000047143	295 x 190 x 100 mm	2	84,00



LM 46478

LM 46413

Verdeelkast - Elektrische werfkast Coffret de distribution électrique



Max. 6400W

Franse stekker
Prise française



	LM 47930	LM 47923
Kabel type / Type de câble	H07RN-F / 5G 2,5 mm ²	H07RN-F / 5G 2,5 mm ²
Kabellengte / Longueur de câble	1,5 m	1,5 m
Max. Watt	6400W	6400W
Min. Watt	960W	960W
Invoer / Entrée	CEE 16A - 5P	CEE 16A - 5P
Uitvoer / Sortie	2 x 400V (16A) 4 x 230V (FR/BE)	2 x 400V (16A) 4 x 230V (SCHUKO)
IP-classificatie / Classification IP	IP44	IP44
Afmetingen / Dimensions	260 x 210 x 180 mm	255 x 250 x 180 mm
Stekkers / Prises	 F B	 D L

code	Barcode	Info	Info	Box	€
LM 47930	5420000067127	6400 W		1	116,00
LM 47923	5420000067110	6400 W		1	116,00

Verdeelkast - Elektrische werfkast met zekering Coffret de distribution électrique avec fusible

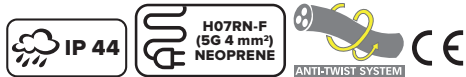

Max. 12800W



met zekering
avec fusible

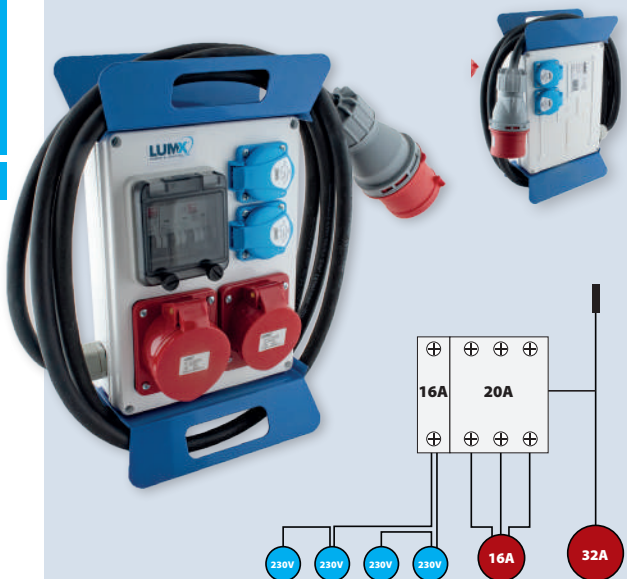

	LM 47986	LM 47954
Kabel type / Type de câble	H07RN-F / 5G 4 mm ²	H07RN-F / 5G 4 mm ²
Kabellengte / Longueur de câble	4 m	4 m
Max. Watt	12800W	12800W
Min. Watt	-	-
Invoer / Entrée	CEE 32A - 5P	CEE 32A - 5P
Uitvoer / Sortie	400V (1 x 32A - 1 x 16A) 4 x 230V (FR/BE)	400V (1 x 32A - 1 x 16A) 4 x 230V (SCHUKO)
IP-classificatie / Classification IP	IP44	IP44
Afmetingen / Dimensions	350 x 210 x 180 mm	350 x 250 x 180 mm
Stekkers / Prises	 F B	 D L

code	Barcode	Info	Info	Box	€
LM 47986	5420000067103	12800 W		1	197,00
LM 47954	5420000067097	12800 W		1	197,00

2024

Brutoprijzen excl. BTW en taksen geldig vanaf 01/08/2024 tot 31/12/2024 - Prix brut hors TVA et taxes valable du 01/08/2024 jusqu'au 31/12/2024

Verdeelkast - Elektrische werfkast Coffret de distribution électrique



EN 61439

Max. 12800W

	LM 47110
Invoer / Entrée	1 x CEE 16A - 5P - 400V
Uitvoer / Sortie	2 x CEE 16A - 400V 4 x 16A - 250V
IP-classificatie / Classification IP	IP44
Afmetingen / Dimensions	200 x 197 x 197 mm
Stekkers / Prises	 F B

code				€
LM 47110	5420000047167	12800 W	1	136,00

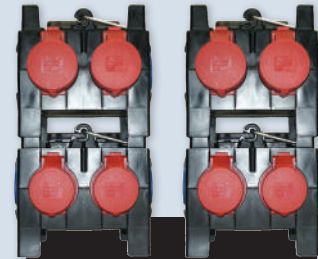

Ruimtebesparende opslag,
boxen zijn stapelbaar
Gain d'espace de stockage
car les boîtiers sont empilables

Verdeelkast - Elektrische werfkast met zekering Coffret de distribution électrique avec fusible



EN 61439



Max. 12800W

	LM 47117
Kabeltype / Type de câble	H07RN-F / 5G 4 mm ²
Kabellengte / Longueur de câble	2 m
Invoer / Entrée	1 x CEE 32A - 5P - 400V
Uitvoer / Sortie	1 x CEE 32A + 1 x 16A - 400V 3 x 16A - 250V
Zekering / Fusible	63A
IP-classificatie / Classification IP	IP44
Afmetingen / Dimensions	200 x 197 x 197 mm
Stekkers / Prises	 F B

code				€
LM 47117	5420000047174	12800 W	1	371,00

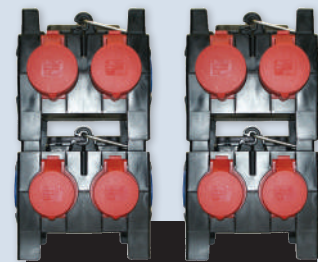

met zekering
avec fusible



Ruimtebesparende opslag,
boxen zijn stapelbaar
Gain d'espace de stockage
car les boîtiers sont empilables

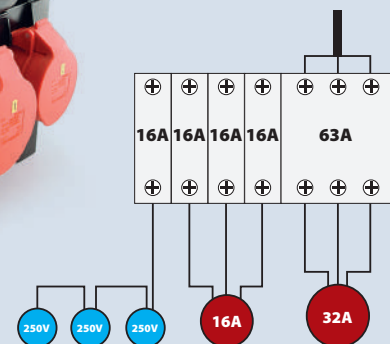

Standaard kabelhaspel BS HOME Enrouleur de câble standard BS HOME



Thermische schakelaar
Disjoncteur thermique

Trommel kunststof
Tambour plastique

BS
HOME
VINYL

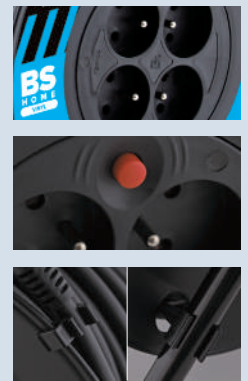

code	Barcode	Length	Country	Quantity	Length (m)	Price (€)
LM 80025	5420000025004	25 m	BE	4	80	55,40
LM 80050	5420000025011	50 m	BE	2	48	94,90

Kabelhaspel PRO met driewegskoppelstekker Enrouleur de câble PRO avec fiche femelle triple

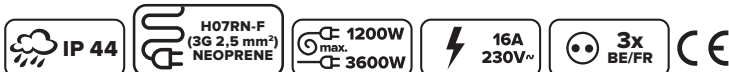

Thermische schakelaar
Disjoncteur thermique

Trommel kunststof
Tambour plastique

PRO
3 - WAY
NEOPRENE
HEAVY DUTY



code	Barcode	Length	Country	Quantity	Length (m)	Price (€)
LM 85728	5420000043633	25 m	BE	2	36	134,00

2024

Brutoprijzen excl. BTW en taksen geldig vanaf 01/08/2024 tot 31/12/2024 - Prix brut hors TVA et taxes valable du 01/08/2024 jusqu'au 31/12/2024

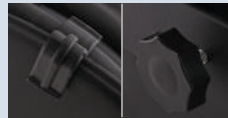
LUMX
POWER & LIGHTING**Kabelhaspel PRO**
Enrouleur de câble PROThermische schakelaar
Disjoncteur thermiqueTrommel kunststof
Tambour plastique**PRO**
NEOPRENE
HEAVY DUTY

code	Barcode	Info	Outlets	Weight	Length	Price	ACTIE ACTION
LM 85025	5420000032255	25 m		2	36	102,00	98,00
LM 85140	5420000063662	40 m		2	36	139,00	129,00

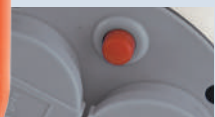
Kabelhaspel XT PREMIUM
Enrouleur de câble XT PREMIUMThermische schakelaar
Disjoncteur thermiqueTrommel aluminium
Tambour alu**XT**
PREMIUM
PUR
HEAVY DUTY

code	Barcode	Info	Outlets	Weight	Length	Price
LM 88740	5420000060630	40 m		2	24	225,00

Kabelhaspel XT PRO NO-TURN Enrouleur de câble XT PRO NO-TURN

IP 44
 H07RN-F (3G 2,5 mm²) NEOPRENE
 1200W max. 3600W
 16A 230V~
 CE

TEMP RESISTANT -35°C / 70°C
 IMPACT RESISTANT 10N/mm

Thermische schakelaar
Disjoncteur thermique

Trommel kunststof
Tambour plastique

XT
P R O
NEOPRENE
HEAVY DUTY



35M

4x BE/FR

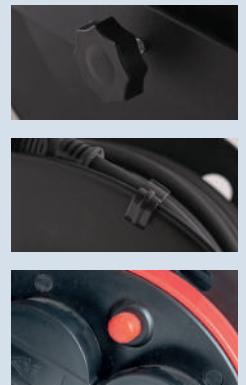

code	barcode	i	⊕	📦	🔌	€
LM 87635	5420000065291	35 m	4x		2 24	149,00

Kabelhaspel XT PRO Enrouleur de câble XT PRO

IP 44
 H07RN-F (3G 2,5 mm²) NEOPRENE
 1200W max. 3600W
 16A 230V~
 CE

TEMP RESISTANT -35°C / 70°C
 IMPACT RESISTANT 10N/mm

LM 87240

4x BE/FR

LM 87278

4x DE/NL

Thermische schakelaar
Disjoncteur thermique

Trommel kunststof
Tambour plastique

XT
P R O
NEOPRENE
HEAVY DUTY



code	barcode	i	⊕	📦	🔌	€	ACTIE ACTION
LM 87240	5420000060616	40 m		2 24	159,00	149,00	
LM 87278	5420000060623	40 m		2 24	159,00		

